

# SRCC ベース付歩車道境界ブロック:A

基本

参考重量340kg

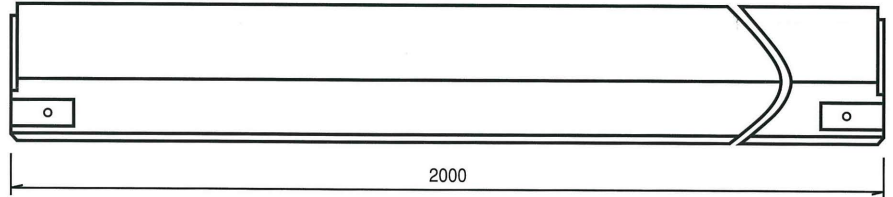
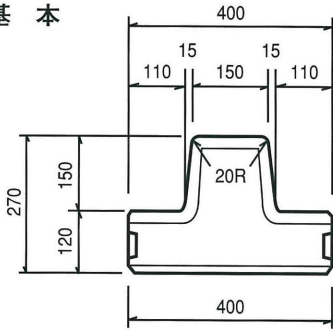

切下げ

参考重量326kg

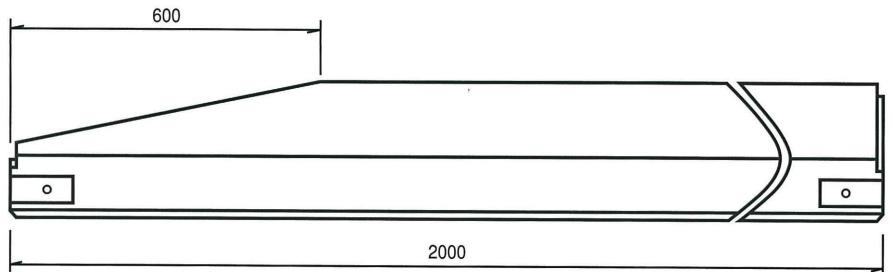
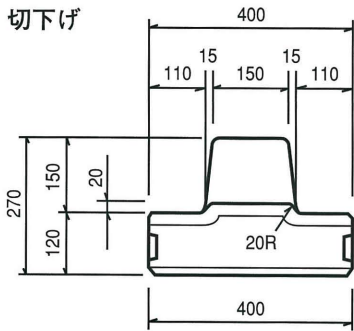

反射付  
切下げ

参考重量325kg

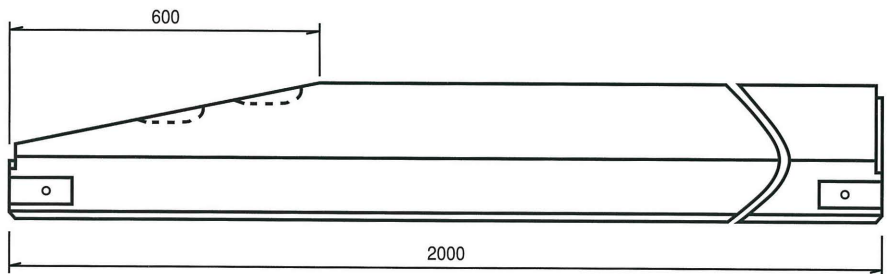
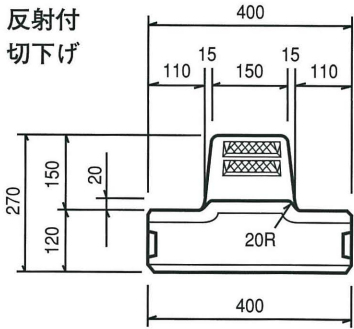

乗入り

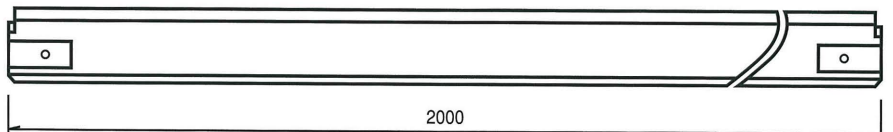
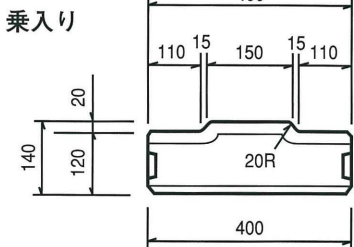

水抜き

